

P2	
VCC_3V3	LDO_3V3
MCU_RX1	Target_VCP_RX
MCU_TX1	Target_VCP_TX
T_NRST	Target_RSTn
MCU_SWCLK	Target_SWCLK
MCU_SWDIO	Target_SWDIO
VDD_3V3	LDO_3V3

Header 7X2

	Title: ***
	Name: *
Drawn by: ***	Revision: ***
Checked by: ***	Date: 2024/12/5
Approved by: ***	Size: A4
	Sheet: *

复位

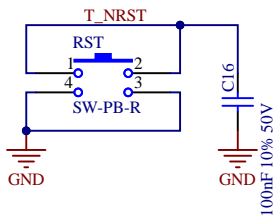

KEY

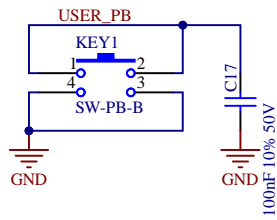

LED

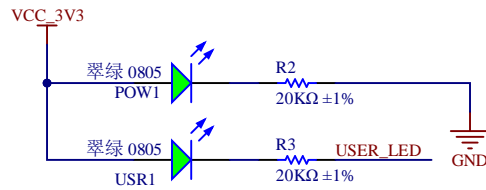

USB OTG1

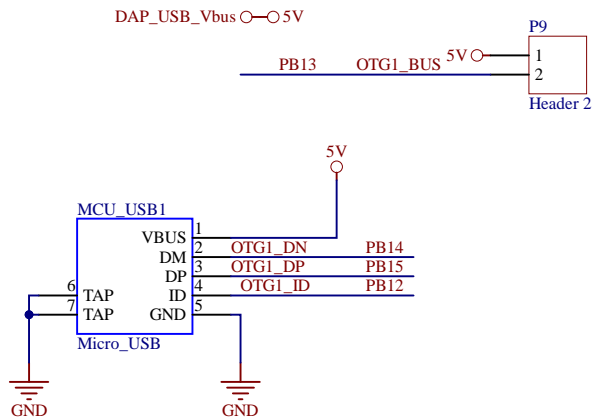

GPIO

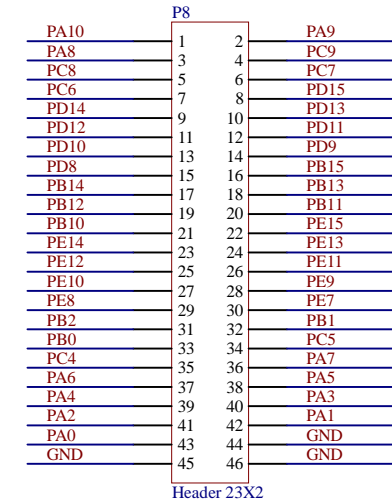
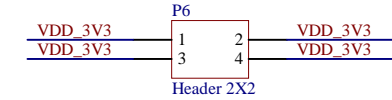
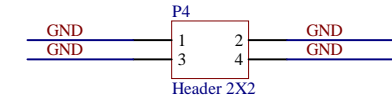
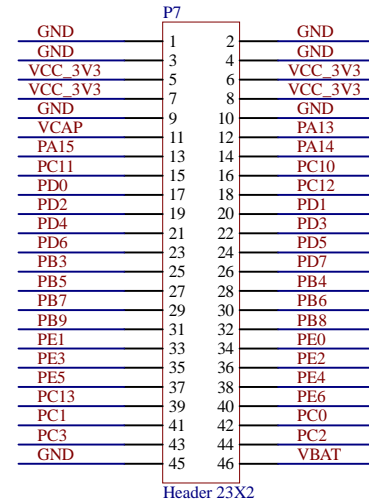
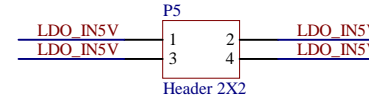
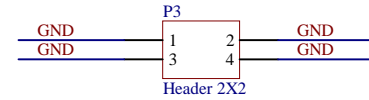

	Title: ***
	Name: *
Drawn by: ***	Revision: ***
Checked by: ***	Date: 2024/12/5
Approved by: ***	Size: A4
	Sheet: *

Comment	Description	Designator	Footprint	LibRef	Quantity
4.7uF 10% 16V	贴片电容	C1, C3, C5, C7, C18, C19, C20, C22, C25	0603_C	0603 4.7uF (475) 10% 16V	9
100nF 10% 50V	贴片电容	C2, C4, C6, C8, C13, C15, C16, C17, C21, C23, C24, C26, C27	0603_C	0603 100nF (104) 10% 50V	13
1uF 10% 50V	贴片电容	C9	0603_C	0603 1uF (105) 10% 50V	1
33pF 5% 50V	贴片电容	C10, C11, C30, C31	0603_C	0603 33pF (330) 5% 50V	4
10uF 10% 10V	贴片电容	C12, C14	0603_C	0603 10uF (106) 10% 10V	2
18pF 5% 50V	贴片电容	C28, C29	0603_C	0603 18pF (180) 5% 50V	2
红灯 0805	发光二极管	COM1	0805_LED_S1	0805 红灯	1
MBR130	二极管	D1, D2	SOD-123	Diode	2
600Ω ±25% 100MHz	贴片磁珠	FB1	0805_L	0805 600Ω 25% 100MHz	1
SW-PB-B	Switch	KEY1	SW-SMD_4P-L6.0-W6.0-P3.90-LS9.5	SW-PB	1
TYPEC_FEMALE_16P	Type C Female	Link_USB1, MCU_USB2	TYPEC-FEMALE-16P	USB_TYPEC_FEMALE_16P	2
Micro_USB	Type B、Type AB	MCU_USB1	USB_Micro/SM0.65-4H5	Micro_USB	1
Header 2	Header, 2-Pin	P1, P9	HDR1X2	Header 2	2
Header 7X2	Header, 7-Pin, Dual row	P2	HDR2X7	Header 7X2	1
Header 2X2	Header, 2-Pin, Dual row	P3, P4, P5, P6	HDR2X2	Header 2X2	4
Header 23X2	Header, 23-Pin, Dual row	P7, P8	HDR2X23	Header 23X2	2
翠绿 0805	发光二极管	POW1, USR1	0805_LED_S1	0805 翠绿	2
20KΩ ±1%	贴片电阻	R1, R2, R3	0603_R	0603 20KΩ (2002) 1%	3
0Ω ±1%	贴片电阻	R4	0603_R	0603 0Ω (0R0) 1%	1
100Ω ±1%	贴片电阻	R5	0603_R	0603 100Ω (1000) 1%	1
SW-PB-R	Switch	RST	SW-SMD_4P-L6.0-W6.0-P3.90-LS9.5	SW-PB	1
SW SMD-1	SMD Switch	SW1	SMD_SW_1WAY_SMD	SW SMD-1	1
ACH512 V2 QFN32U	ACH512 V2 QFN32U	U1	QFN 5X5-32/P.5	ACH512 V2 QFN32U	1
ACM32H538VMT6-TM	叠封4MB Flash (TH25Q32HA), 8MB PSRAM (APS6408L-30BMx), 兼容ST封装	U2	F-QFP14X14-G100/Z17N	ACM32H538VMT6-TM_LQFP100_SchVer	1
AMS1117-3.3	低压差线性稳压 (LDO)	VR1	SOT-223	SOT-223 AMS1117-3.3	1
12MHZ 20PF 10PPM	贴片晶振	Y1, Y2	SMD-3225_4P	SMD-3225_4P 12MHZ 20PF 10PPM	2
32.768KHz ±20ppm 12.5pF	贴片晶振	Y3	SMD-3215_2P FC -135	SMD-3215_2P 32.768KHz 20ppm 12.5pF	1